

**POLYSTYRENE DECORATION
BUILDING SYSTEM**

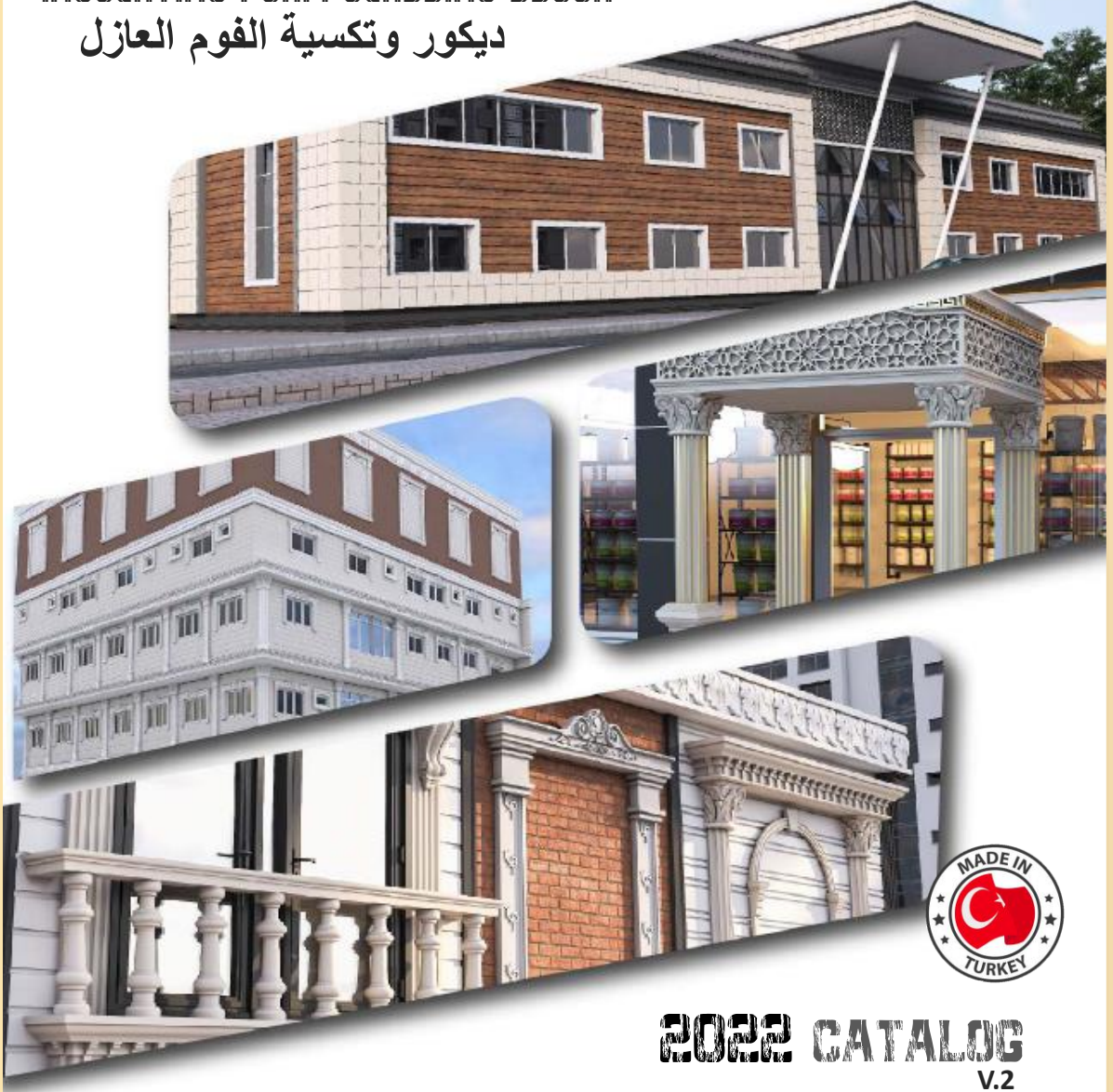

INSULATING FOAM CLADDING DECOR
ديكور وتكسية الفوم العازل



2022 CATALOG
V.2

ما هي مادة المنتج EPS ؟

EPS مادة عزل رغوية بلاستيكية خفيفة الوزن وصلبة. مصنوعة من حبيبات صلبة من البوليسترين. يتم تحقيق الامتداد في عملية البخار لتشكيل بنية خلية مغلقة تمامًا. تشغل هذه الخلايا ما يقرب من 40 ضعف حجم حبة البوليسترين الأصلية. في الخطوة التالية ، يتم تشكيل المادة في عبارة عن هواء هندسي بنسبة 98 ٪ ، وهي مادة بلاستيكية EPS أشكال مناسبة تناسب تطبيقاتها. تغلف الهواء ، وتسخير فائدتها كمواد عازلة ممتازة وامتصاص الصدمات.

WHAT IS EPS?

EPS with the technical term is Expanded Polystyrene. It is a lightweight, rigid, plastic foam insulation material. Produced from solid beads of polystyrene. The extension is achieved in a steamed process to form a perfectly closed cell structure. These cells occupy approximately 40 times the volume of the original polystyrene bead. In the next step, the material is moulded into appropriate forms suited to their applications. EPS is 98% engineered air, the plastic material encapsulating the air, harnessing its benefit as excellent insulation and shock absorption material.

- **Comfort Cover.**
- **Trouble shooter.**
- **Protective.**
- **Economical, and cost-saving solution.**

98% EPS to be Precise.

Nothing insulates better than Air.



جميع المنتجات المصنعة من البولستيرين EPS ذات كثافة عالية

الميزات والخصائص:

- ١- القياس الطولي لإلواح البولستيرين 200 سم .
- ٢- متوفرة بأشكال وأحجام ونماذج مختلفة حسب الطلب.
- ٣- غير قابل للإشتعال والذوبان.
- ٤- قدرة العزل الحراري.
- ٥- صديقة للبيئة وسهلة الاستخدام..
- ٦- سهولة التجميع وسرعة التركيب.
- ٧- ضمان مدى الحياة.
- ٨- اللون الأساسي (الرملي). تغيير حسب الطلب.

All manufactured products are produced with high-density EPS.

FEATURES AND PROPERTIES:

1. Standard length 200 x 50 cm Board.
2. Different Sizes and Models are available upon request.
3. Classification B1 Noninflammable Product.
4. Thermal Insulation Capability
5. Environmental and User Friendly.
6. Simple Assembly and Fast Installation.
7. Lifetime Warranty.
8. Standard Exteriors Color (Sand) - customizing option upon request.

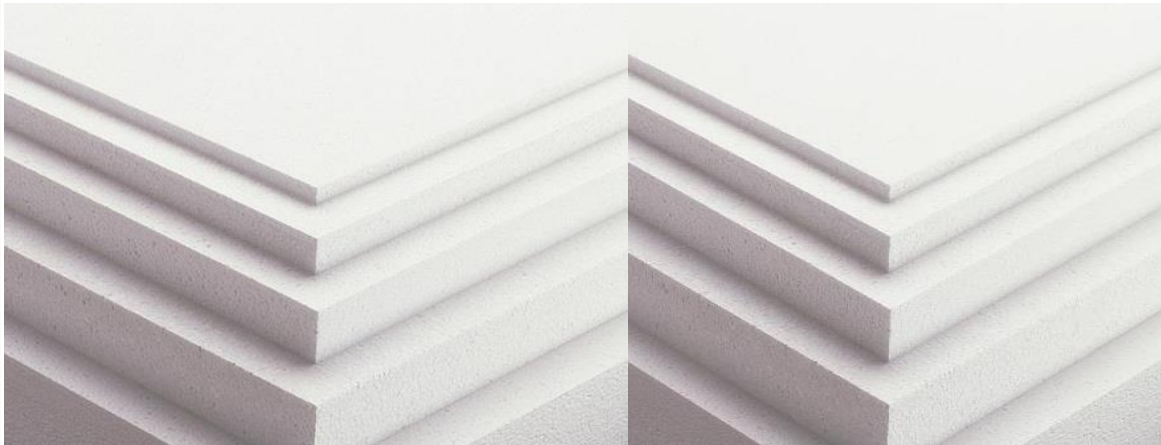

عزيزى العميل،

تقدم مجموعة وسق حلول وبدائل أكثر توفير وسريعة التركيب لكساء المنشآت والمباني والديكور الخارجي والداخلي مع خاصية العزل الحراري والرطوبة وخفض البرودة والصوت وهي تكسية الفوم العازل بأشكال وسماكة مختلفة لعمر خدمة أطول ولتناسب التأثيرات المناخية وعوامل الطبيعة في بيئة قاسية. والمنتج صنع فى تركيا وحائز علي شهادات من مراكز الجودة العالمية في الإنتاج والصناعة.

المواد الأساسية المستخدمة في التصنيع هي البلولستيرين ذو ضغط وكثافة عالية مقاومة للحرارة والماء ومن الخارج مادة الأكليريك لتكوين صلابة أكثر ومع إضافة بودرة الرخام سيعطي الشكل الحجري.

نوفر عدة تصاميم كساء الواجهات الحجرى ومختلف قطع الأكسسوار والزخارف لتزين الشكل الجمالي الكلي للمبني مع إشراف وتنفيذ وكفالة المصنع.

تواصل معنا لمعرفة الخدمات والعروض المتاحة والتي تشمل راحتكم.



DESIGNED AND DEVELOPED
FOR SUSTAINABLE PERFORMANCE

تم تصميم وتطوير المنتج
لتحقيق أداء طويل الأمد

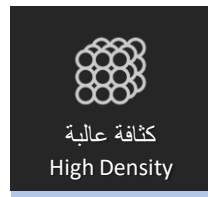
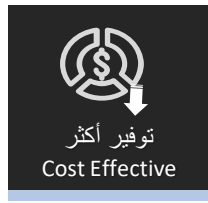
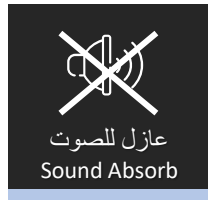

INDEX

PAGES - صفحات

المحتوي

1	EPS PAPIER MACHE	08 - 12	بنل فلين داخلي	١
2	INTERIOR LATH	13	الركيزة	٢
3	LIGHT STRIP COVERING	14 - 15	تغطية شريط الضوء	٣
4	CEILING LIGHT	16 - 17	إضاءة الأسقف	٤
5	TV UNITS	18	وحدات التلفاز	٥
6	EXTERIOR ORNAMENT	19 - 21	زخارف خارجية	٦
7	EPS PAPIER MACHE	22 - 24	بنل فلين داخلي	٧
8	LATH	25	الركيزة	٨
9	LAMPS CORE MEDALLIONS	26 - 27	ميداليات إضاءة السقف	٩
10	CEILING TILE	28 - 29	ديكور السقف	١٠
11	FRAMES (DOOR & WINDOW)	30 - 33	إطار الأبواب والنوافذ	١١
12	CROWNS	35 - 36	التاج	١٢
13	CROWNS DECOR	37 - 38	ديكور قمة التاج	١٣
14	FLOOR STRINGERS	39	كورنيش كساء خارجي	١٤
15	WINDOWS STILLS	40 - 44	عتبة النوافذ	١٥
16	FENCE COVERS	45	غطاء سياج	١٦

INDEX

PAGES - صفحات

المحتوي

17	EXTERIOR LATH	46	الركيزة	١٧
18	CORNER STONE COVER	47 - 48	غطاء حيز زاويا	١٨
19	PIPES CLOSING	49	غطاء أنابيب	١٩
20	PILLARS AND BASE	50 - 55	الأعمدة و القواعد	٢٠
21	WINDOWS FENCE PILLARS	56	أعمدة وسياج النوافذ	٢١
22	CORBELS	57 - 58	دعامة أسقف	٢٢
23	KEY STONES	59 - 60	حجر قفل	٢٣
24	ROSETTE	61	رشيد	٢٤
25	MOTIF	62 - 64	قطع زخرفة	٢٥
26	WALL CLADDING	65 - 69	كساء الواجهات	٢٦
27	WINDOWS FRAME	70 - 71	إطار النوافذ	٢٧
28	QUALITY CERTIFICATE	72	شهادات الجودة	٢٨



CKP 01



CKP 10

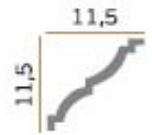

CKP 06

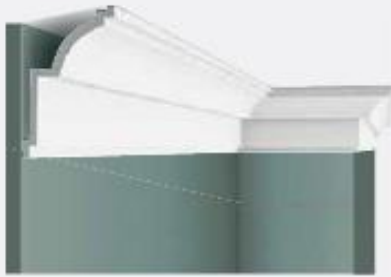

CKP 11



CKP 07

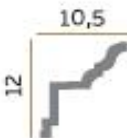

CKP 12



CKP 08

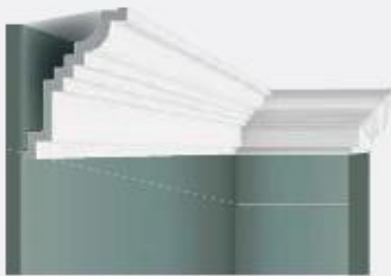

CKP 13



CKP 09

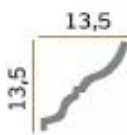

CKP 14



CKP 19

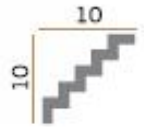

CKP 15



CKP 20



CKP 16

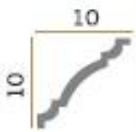

CKP 21

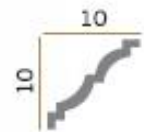

CKP 17



CKP 22

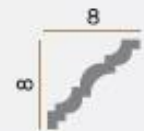

CKP 18

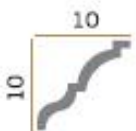

CKP 23



CKP 24



CKP 29

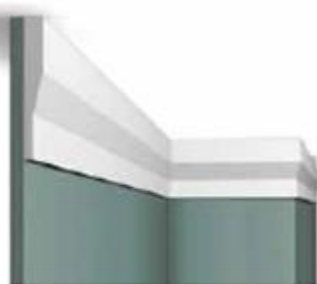

CKP 25



CKP 35



CKP 26

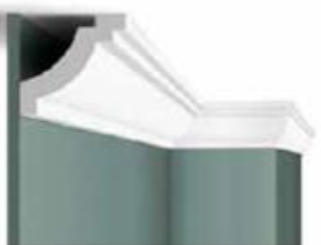

CKP 36



CKP 27



CKP 37

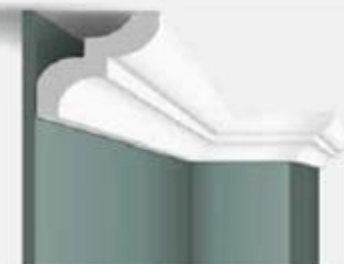

CKP 28



CKP 38

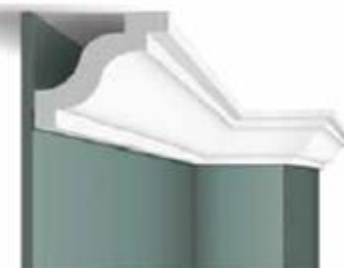

CKP 39

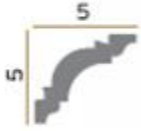

CKP 46

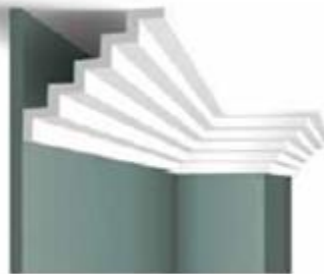
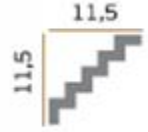

CKP 40

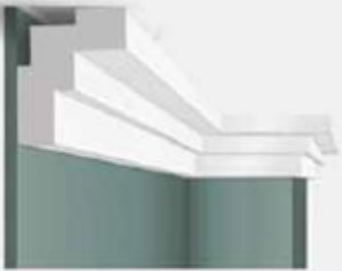

CKP 47



CKP 41



CKP 48



CKP 42

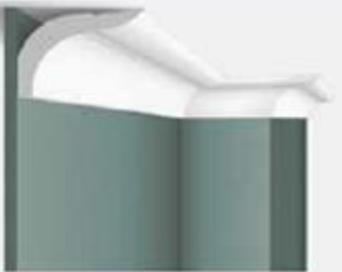

CKP 49



CKP 45

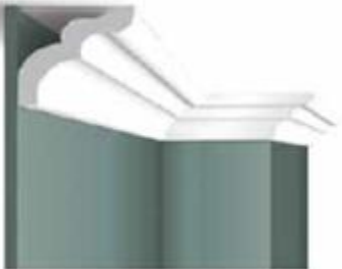

CKP 50

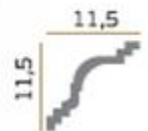

CKP 51



CKP 56



CKP 52

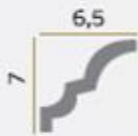

CKP 57



CKP 53

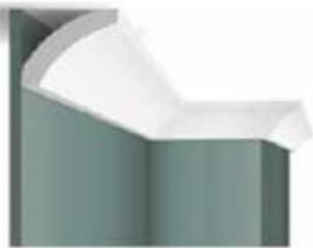

CKP 58



CKP 55



CKP 59



CPT 08



CPT 10



CPT 12



CKP 30



CKP 32

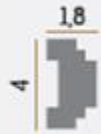

CKP 31



CKP 33



CKP 60



CKP 61



CIB 02



CIB 08

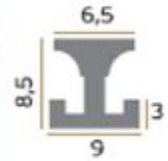

CIB 03



CIB 09



CIB 04

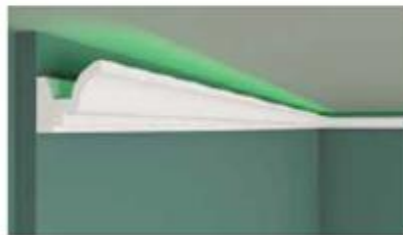

CIB 10



CIB 05

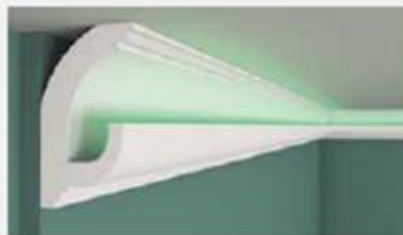

CIB 11



CIB 07



CIB 12



CIB 13



CIB 18



ÇİM'ler için taşıyıcı olarak kullanılmaktadır.

CIB 15



CIB 19



ÇİM'ler için taşıyıcı olarak kullanılmaktadır.

CIB 16



CIB 20



CIB 17



CIB 21



CAT 05



CAT 07



CAT 06



CAT 08



CONTROLLABLE MATERIAL TO DECORATE ALL
YOUR NEEDS

مادة سهلة التحكم لتزيين جميع احتياجاتك



CTV 01



CTV 04



CTV 02



CTV 05



CTV 03



CTV 06



Yaşamınızı

Güzelleştiren

Detaylar...



CIM 01



CIM 03



CIM 02



CIM 04



CiM 05



2x50x100 cm

CiM 08



2x50x100 cm

CiM 06



2x50x100 cm

CiM 09



2x50x100 cm

CiM 07



2x50x100 cm

CiM 10

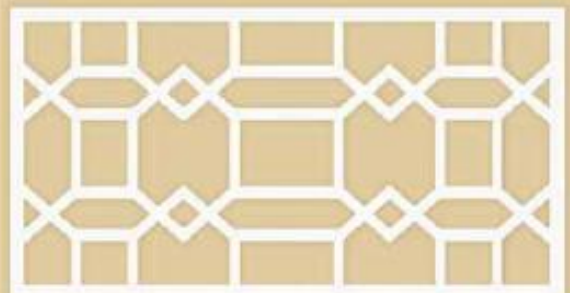

2x50x100 cm

CEDK 02

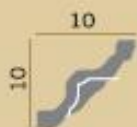

CEDK 03

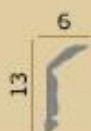

CEDK 06

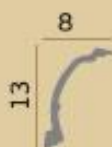

CEDK 10



CEDK 11



CEDK 12



CEDK 13

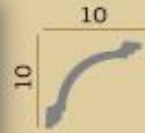

CEDK 14

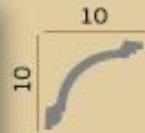

CEDK 17



CEDK 18



CEDK 19



CEDK 21



CEDK 22



CEDK 23



CEDK 24



CEDK 25

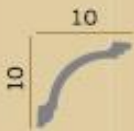

CEDK 27



CEDK 28

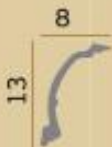

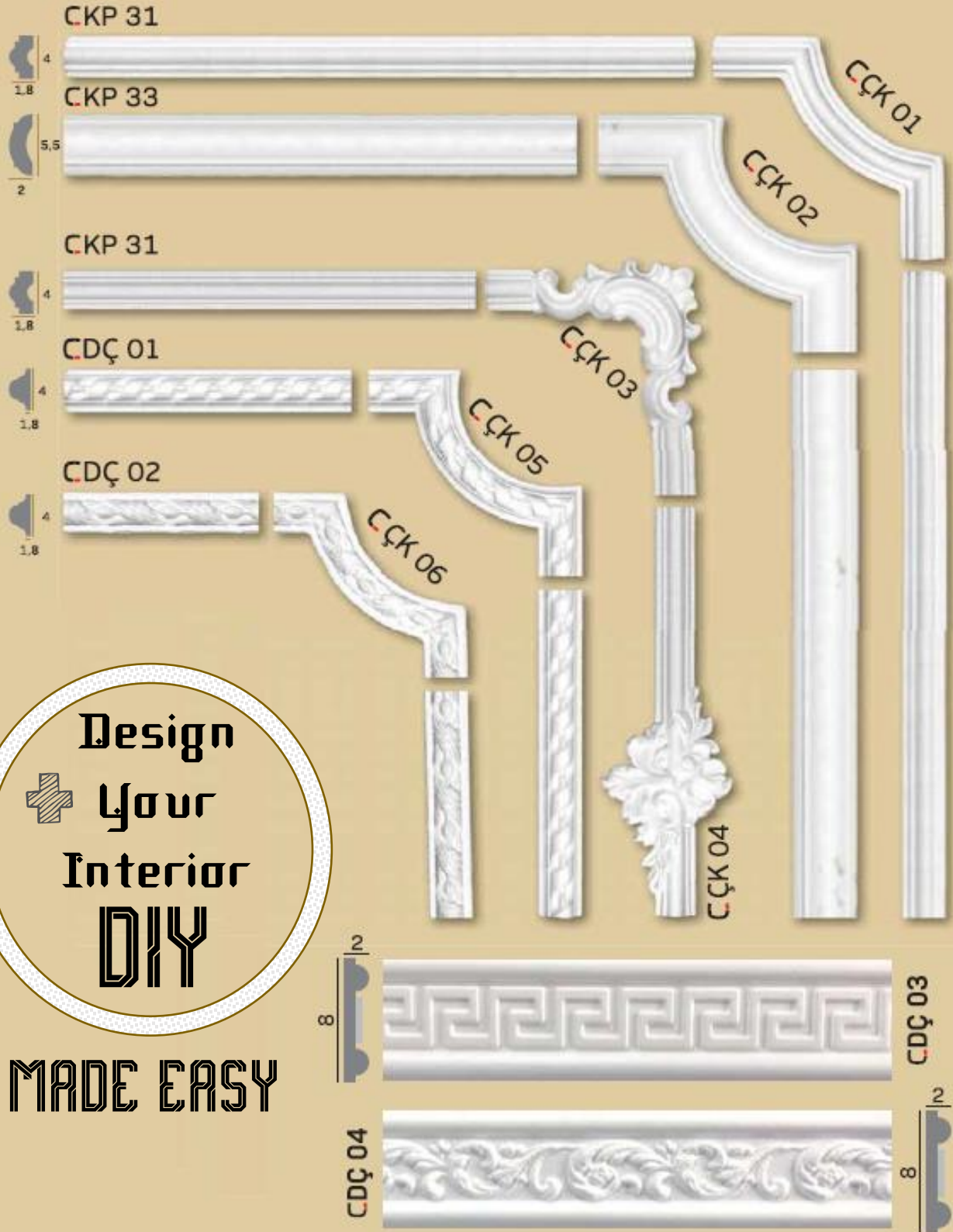

Design
 + Your
 Interior
 DIY

MADE EASY

CGB 01



Ø39
Ø47
Ø55

CGB 04



Ø39
Ø47

CGB 02



Ø39
Ø47

CGB 05



Ø39
Ø47

CGB 03



Ø39
Ø47



CGB 07



Ø47
Ø55
Ø70

CGB 10



Ø70

CGB 08



Ø55

CGB 11



Ø55

CGB 09



Ø70

CGB 12



Ø70

CTK 02



50x50

CTK 08



50x50

CTK 03

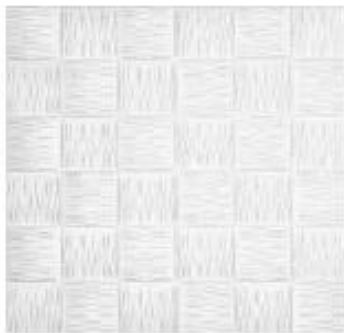

50x50

CTK 09



50x50

CTK 05

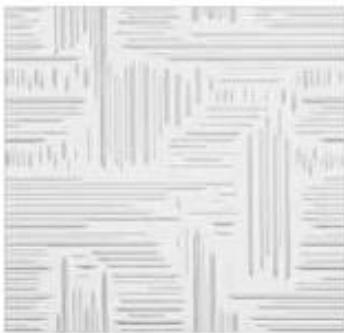

50x50

CTK 10

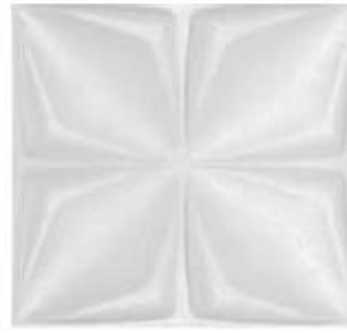

50x50

CTK 07



50x50

CTK 11



50x50

CSV 01



CSV 07



CSV 02



CSV 08



CSV 03



CSV 09



CSV 04



CSV 10



CSV 05



CSV 11



CSV 06



CSV 12



CSV 13



CSV 19



CSV 14



CSV 20



CSV 15

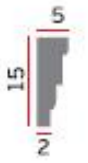

CSV 21



CSV 16



CSV 22



CSV 17



CSV 23



CSV 18



CSV 24



CSV 25



CSV 31



CSV 26

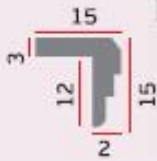

CSV 33



CSV 27

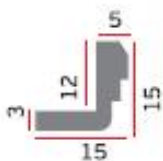

CSV 34



CSV 28



CSV 35



CSV 29

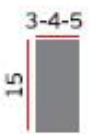

CSV 38



CSV 30



CSV 39



CSV 40

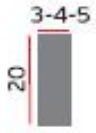

CSV 51

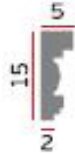

CSV 41



CSV 52



CSV 42



CSV 55



CSV 44



CSV 56



CSV 46



CSV 57

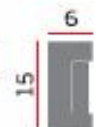

CSV 50



CSV 58



CSV 59



CSV 65



CSV 60



CSV 66



CSV 61

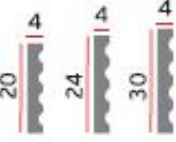

CSV 67



CSV 62



CSV 68

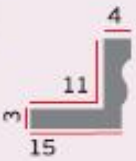

CSV 63



LAMBIRI

CSV69



CSV 64

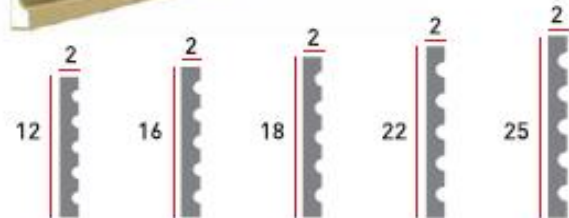

Urunumuz XPS hammaddeden uretilmektedir.

CSV 70



CSV 71



CTAÇ 01



CTAÇ 07



CTAÇ 02



CTAÇ 08



CTAÇ 03



CTAÇ 09



CTAÇ 04



CTAÇ 10



CTAÇ 05

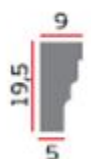

CTAÇ 11



CTAÇ 06



CTAÇ 12



CTAÇ 13



CTAÇ 19



CTAÇ 14



CTAÇ 20

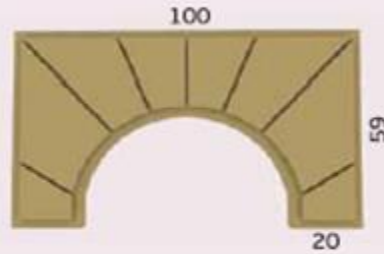

CTAÇ 15



CTAÇ 21



CTAÇ 16

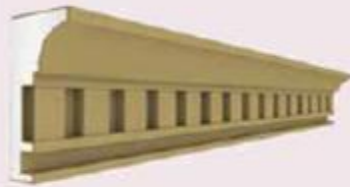

CTAÇ 22



CTAÇ 17



CTAÇ 23



CTAÇ 18



CTD 01



• 80x25x5 • 100x30x5 • 120x35x5

CTD 07



• 80x25x5 • 100x30x5 • 120x35x5

CTD 02



• 80x52x5 • 100x53x5 • 120x63x5

CTD 08



• 80x25x5 • 100x30x5 • 120x35x5

CTD 03



• 80x25x5 • 100x30x5 • 120x35x5

CTD 09



• 80x25x5 • 100x30x5 • 120x35x5

CTD 04



• 80x25x5 • 100x30x5 • 120x35x5

CTD 12



• 80x25x5 • 100x30x5 • 120x35x5

CTD 05



• 80x25x5 • 100x30x5 • 120x35x5

CTD 13



• 80x25x5 • 100x30x5 • 120x35x5

CTD 06



• 80x25x5 • 100x30x5 • 120x35x5

CTD 14



• 80x25x5 • 100x30x5 • 120x35x5

CTD 15



• 80x16x5 • 100x20x5 • 120x24x5

CTD 20



• 100x37x5 • 120x37x5 • 150x37x5 • 200x37x5

CTD 16



• 80x22x5 • 100x27x5 • 120x32x5

CTD 21



• 100x35x5 • 120x42x5

CTD 17



• 80x24x5 • 100x30x5 • 120x36x5

CTD 22



• 150x50x7 • 200x50x7

CTD 18



• 80x24x5 • 100x30x5 • 120x36x5

CTD 23



• 150x50x8 • 120x40x8 • 310x80x10

CTD 19



• 80x37x5 • 100x46x5 • 120x55x5

TÜM ÇTD MODELLERİMİZDE
ÖZEL ÖLÇÜDE
SİPARİŞ VEREBİLİRSİNİZ.

Denizlik ve Taç Kapak
Sill and Crown Cover / العبات وغطاء التاج

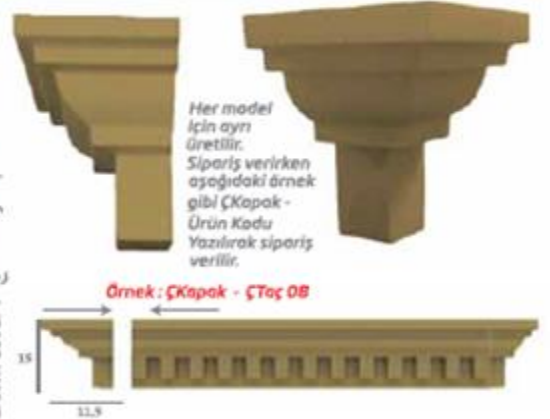

Tüm Denizlik ve Taç Modellerine Göre Üretilmektedir.
It can be produced according to all Sill and crown models.
تستطيع أن تنتج حسب كل موديلات العبات و التاج

CKS 01



CKS 08



CKS 02



CKS 09



CKS 04



CKS 10



CKS 05



CKS 11



CKS 06



CKS 12



CKS 07



CKS 13

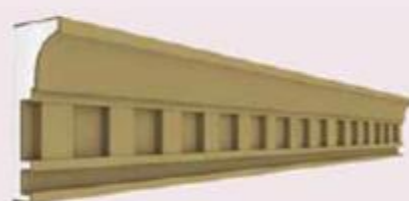
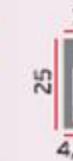

CDN 14



CDN 18



CDN 15



CDN 19



CDN 16



CDN 20



CDN 17



CDN 21



CDN 02



CDN 08



CDN 03



CDN 09



CDN 04



CDN 10



CDN 05



CDN 11



CDN 06



CDN 12



CDN 07



CDN 13



CKS 14



CKS 20



CKS 15



CKS 21



CKS 16

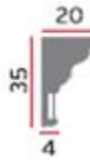

CKS 22



CKS 17



CKS 23

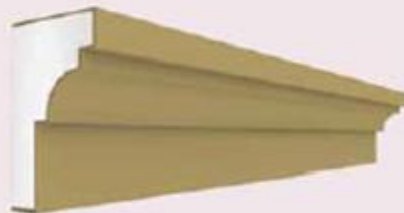

CKS 18



CKS 24

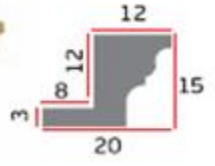

CKS 19



CKS 27



CKS 28



CKS 35



CKS 30



CKS 37



CKS 31



CKS 38



CKS 32



CKS 39



CKS 33



CKS 40



CKS 34



CKS 41



CKS 42



CKS 47

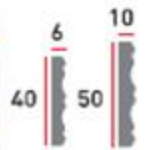

CKS 43



CKS 48



CKS 44



CKS 49

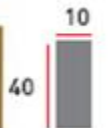

CKS 45

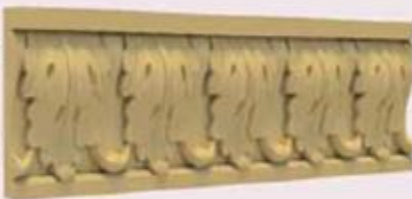

CKS 50

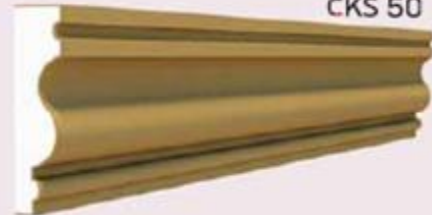

CKS 46

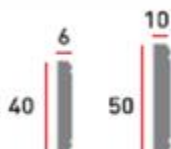

CHP 01

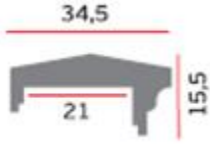

CHP 03

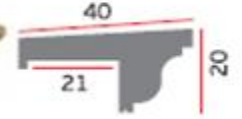
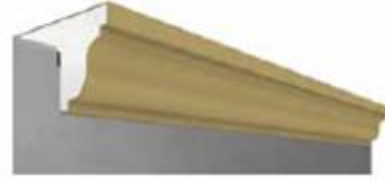

CHP 02



CHP 04



Insulator Bauliban
بوتلين عازل

CMT 01



Mantolama Çıtası

CMT 03

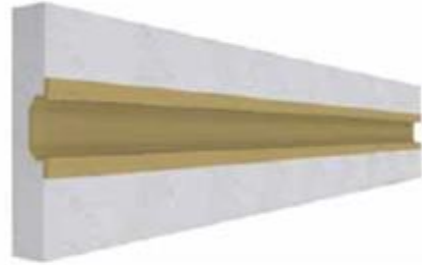

CMT 02



CMT 04

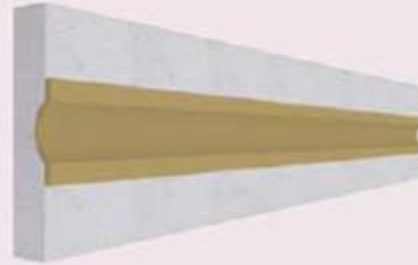

Window Corner Decor
ديكورات زوايا النافذة

CYP 01



90 ve 120cm.
ölçülerinde üretilmektedir.

Yuvarlak Pencere

CYP 03



90 ve 120cm.
ölçülerinde üretilmektedir.

CYP 02



90 ve 120cm.
ölçülerinde üretilmektedir.

CYP 04



90 ve 120cm.
ölçülerinde üretilmektedir.

CÇT 01



CÇT 10



CÇT 02



CÇT 11



CÇT 03



CÇT 12

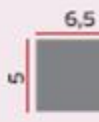

CÇT 04



CÇT 13



CÇT 05



CÇT 14



CÇT 06



CÇT 15



CÇT 07



CÇT 16



CÇT 08



CÇT 17



CKE 01



CKE 16



CKE 02



CKE 17



CKE 03



CKE 19



CKE 04



CKE 26



CKE 05



CKE 27



CKE 11



CKE 28



CKE 12



CKE 29

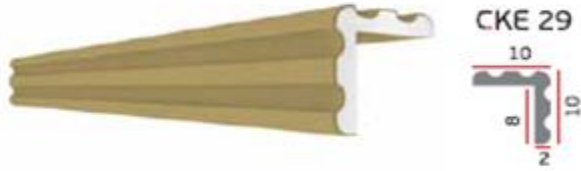

CKE 15



CKE 13



CKE 14



CKE 18



CKE 20



CKE 21



CKE 22



CKE 24



CKE 30



CKE 31



CKE 32



CKE 33



CKE 34



CKE 35



CKE 36



CKE 37





CBK01



- Ø 10
- Ø 12
- Ø 18



CBK02



- Ø 10
- Ø 12
- Ø 18



CBK03

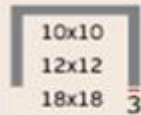

- Ø 10
- Ø 12
- Ø 18



CBK04



- Ø 10
- Ø 12
- Ø 18



CBK05



- Ø 10
- Ø 12
- Ø 18



CBK06



- Ø 10
- Ø 12
- Ø 18

Column
دنگ

CKLN 01



CKLN 09

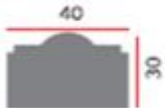

CKLN 02



CKLN 10



CKLN 03



CKLN 04



CKLN 05



CKLN 06



CKLN 07

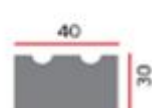

CKLN 08



Kolon



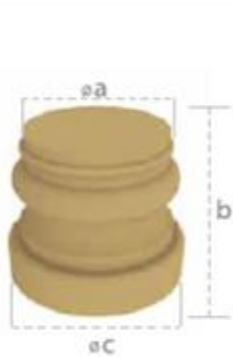
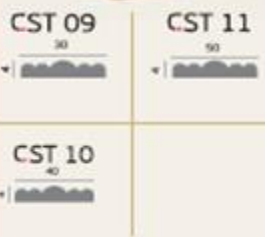
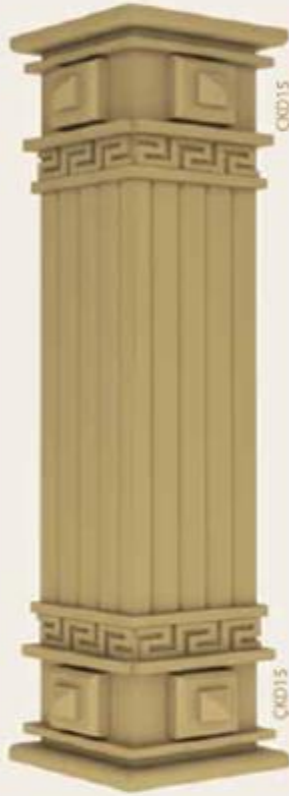

CKD 01	ea:22 ec:30 b:25	CKD 03	ea:42 ec:50 b:25
CKD 02	ea:32 ec:40 b:25	CKD 88	ea:52 ec:60 b:25

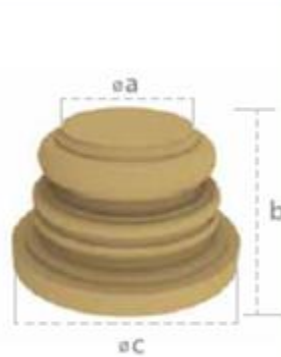

CKD 06	ea:22 ec:30 b:25	CKD 22	ea:42 ec:50 b:25
CKD 21	ea:32 ec:40 b:25		

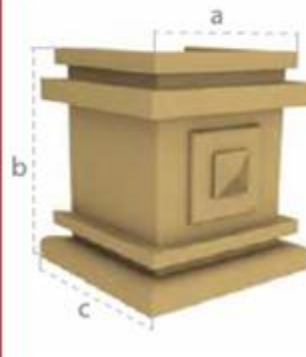

CKD 20	a:22 c:11 b:40	CKD 04	a:32 c:16 b:40
CKD 05	a:42 c:21 b:40	CKD 89	a:52 c:26 b:40

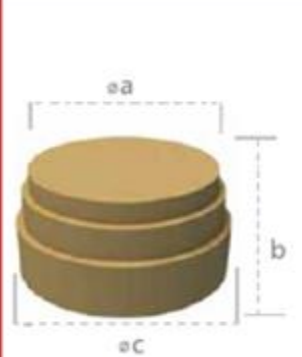

CKD 07	ea:22 ec:30 b:25	CKD 24	ea:42 ec:50 b:25
CKD 23	ea:32 ec:40 b:25		

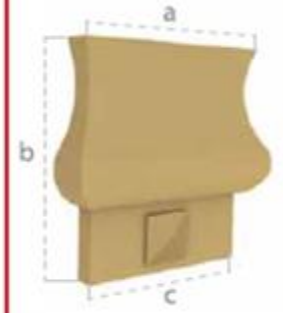
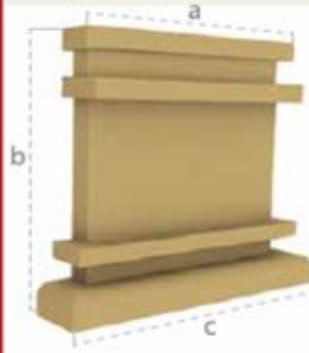
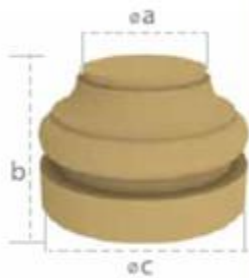
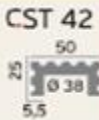
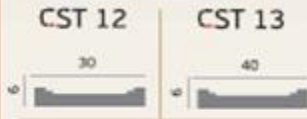
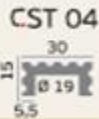
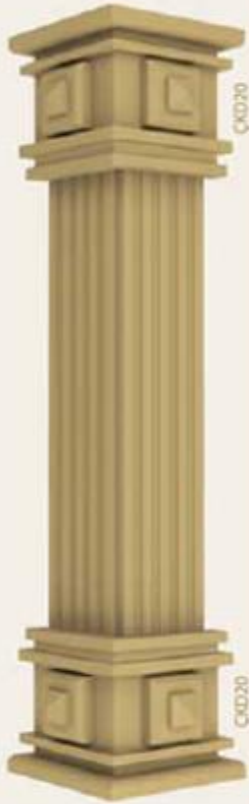

CKD 08	Øa:22	Øc:30	b:25	CKD 26	Øa:42	Øc:50	b:25
CKD 25	Øa:32	Øc:40	b:25	CKD 90	Øa:52	Øc:60	b:25

CKD 18	a:40	c:33	b:25	CKD 30	a:60	c:53	b:25
CKD 29	a:50	c:43	b:25	12 cm. kalınlığında üretilmektedir.			

CKD 12	a:33	c:40	b:40	CKD 14	a:53	c:60	b:40
CKD 13	a:43	c:50	b:40	5 cm kalınlığında üretilmektedir.			

CKD 19	a:40	c:33	b:35	CKD 32	a:60	c:53	b:35
CKD 31	a:50	c:43	b:35	7 cm. kalınlığında üretilmektedir.			



CST 25 CST 26



CST 27

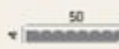

CST 28 CST 29



CST 30 CST 43



CST 31 CST 32



CST 33 CST 44



CST 34 CST 35



CST 36 CST 45

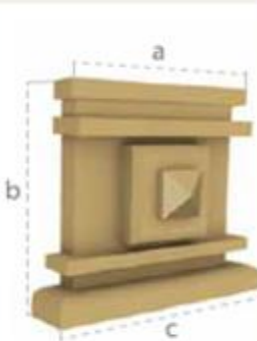

CKD 09 a:33 c:40 b:40
 CKD 11 a:53 c:60 b:40
 CKD 10 a:43 c:50 b:40
 5 cm kalınlığında üretilmektedir.

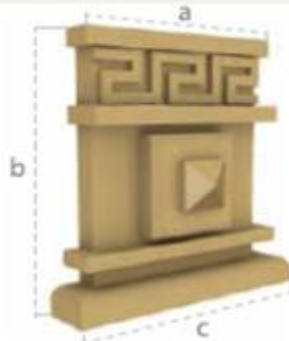

CKD 15 a:33 c:40 b:40
 CKD 17 a:53 c:60 b:40
 CKD 16 a:43 c:50 b:40
 8 cm kalınlığında üretilmektedir.



CKD 33 a:22 c:30 b:15
 CKD 35 a:42 c:50 b:15
 CKD 34 a:32 c:40 b:15
 CKD 91 a:52 c:60 b:15

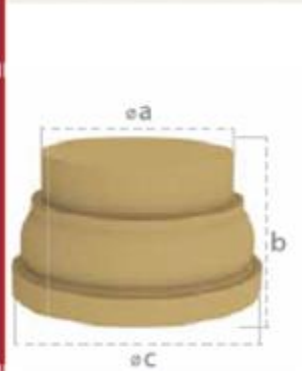

CKD 36 a:22 c:30 b:15
 CKD 38 a:42 c:50 b:15
 CKD 37 a:32 c:40 b:15
 CKD 92 a:52 c:60 b:15



CST 37	CST 38
20	30
10	15
CST 39	CST 46
40	50
20	25

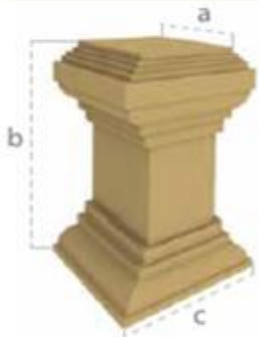

CKD 51	a:22	CKD 53	a:42
	c:32		c:52
	b:50		b:100
CKD 52	a:32		
	c:42		
	b:80		



CST 28	CST 29
20	30
10	15
CST 30	CST 43
40	50
20	25

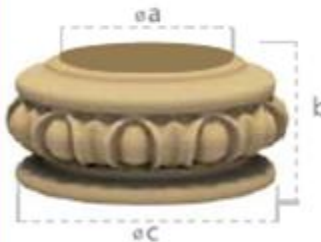

CKD 115	a:22	CKD 117	a:42
	c:30		c:50
	b:15		b:22
CKD 116	a:32		
	c:40		
	b:15		



CST 22	CST 23
20	30
10	15
4	5
Ø 12	Ø 20
CST 24	CST 41
40	50
20	25
5	6
Ø 30	Ø 38

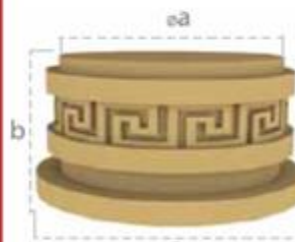

CKD 69	a:22	CKD 71	a:52
	c:30		c:60
	b:32		b:32
CKD 70	a:42		
	c:50		
	b:32		
CKD 114	a:32		
	c:40		
	b:32		



CKD 55	a:14	CKD 56	a:18
	c:35		c:45
	b:20		b:25
CKD 54	a:10		
	c:25		
	b:15		



CKD 72	a:54	CKD 74	a:103
	c:22		c:42
	b:19,5		b:37,5
CKD 73	a:78,5		
	c:32		
	b:28,5		

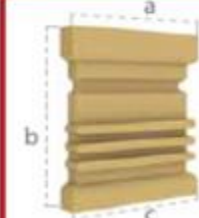

CKD 66	a:32	CKD 68	a:52
	c:32		c:52
	b:30		b:30
CKD 67	a:42		
	c:42		
	b:30		
	4 cm kalınlığında üretilmektedir		



CKD 58	a:42	CKD 59	a:52
	c:55		c:65
	b:15		b:15
CKD 57	a:32		
	c:45		
	b:15		



CKD 60	a:30	CKD 62	a:50
	c:42		c:62
	b:15		b:15
CKD 61	a:40		
	c:52		
	b:15		



CST 47 CST 49



CST 48



CST 50 CST 52



CST 51



CST 53 CST 55



CST 54



CST 56 CST 58



CST 57



CKD 75	a:35	CKD 77	a:65
	c:22		c:42
	b:40		b:50
CKD 76	a:50	CKD 78	a:80
	c:32		c:52
	b:50		b:50



CKD 81	a:32	CKD 83	a:60
	c:22		c:42
	b:40		b:50
CKD 82	a:46	CKD 84	a:75
	c:32		c:52
	b:50		b:50



CKD 96	a:51	CKD 98	a:80
	c:32		c:52
	b:50		b:50
CKD 97	a:64		
	c:42		
	b:50		



CKD 99	a:56,5	CKD 101	a:79
	c:32		c:52
	b:50		b:50
CKD 100	a:70,3		
	c:42		
	b:50		



CKD 102 a:52 c:32 b:50	CKD 104 a:82 c:52 b:50
CKD 103 a:65 c:42 b:50	

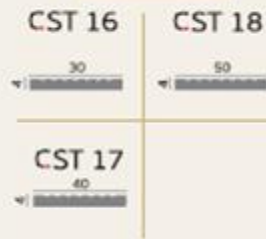

CKD 105 a:50 c:35 b:50	CKD 107 a:75 c:55 b:50
CKD 106 a:62 c:45 b:50	16,5 cm kalınlığında Üretilmektedir.



CKD 108 a:56 c:35 b:50	CKD 110 a:90 c:55 b:50
CKD 109 a:72 c:45 b:50	15 cm kalınlığında Üretilmektedir.

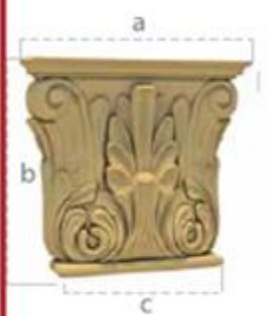
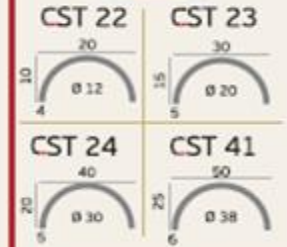

CKD 111 a:50 c:35 b:50	CKD 113 a:77 c:55 b:50
CKD 112 a:62 c:45 b:50	12,5 cm kalınlığında Üretilmektedir.

CBLS 01



CBLS 02



CBLS 03

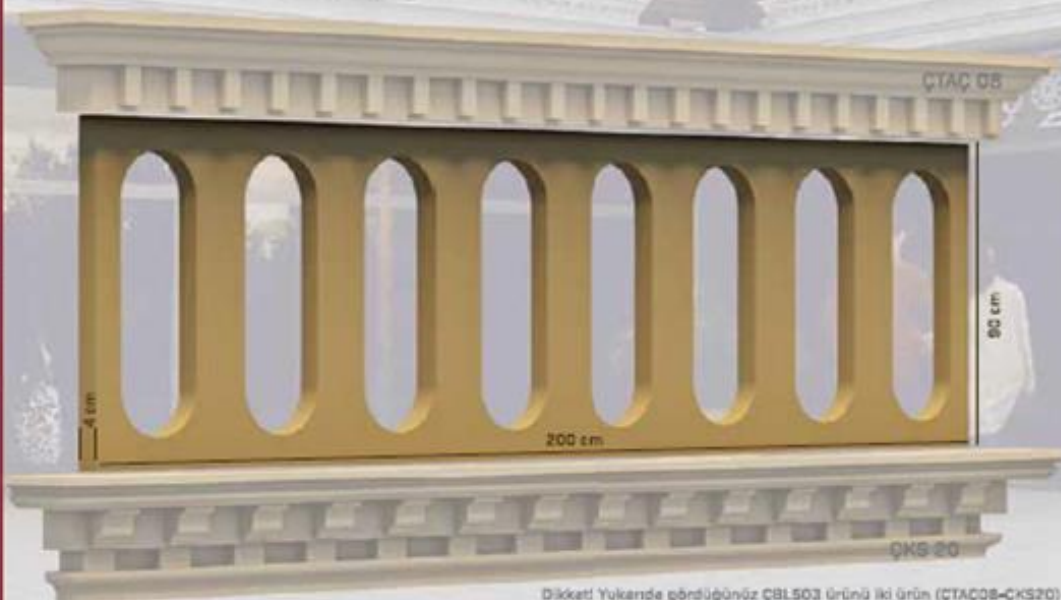

Dikkat! Yukeride görüldüğüüz ÇBL503 ürünü iki ürün (ÇTAÇ05-ÇKS20) arasında kalen Gründür. Diđer ürünler nezd kullanılocağına göstermek amaceyla konulmuştur.

15-20-25-30 CPY 01

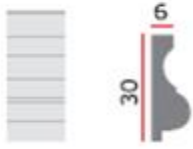

15-20-25-30 CPY 07

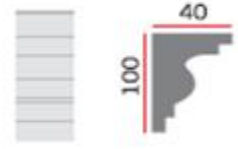

15-20-25-30 CPY 02



15-20-25-30 CPY 08



15-20-25-30 CPY 03



15-20-25-30 CPY 09

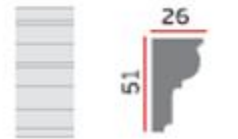

15-20-25-30 CPY 04



15-20-25-30 CPY 10



15-20-25-30 CPY 05



15-20-25-30 CPY 11

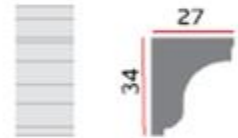

15-20-25-30 CPY 06



15-20-25-30 CPY 12



15-20-25-30 CPY 13



15-20-25-30 CPY 21

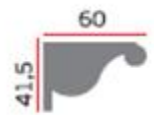

15-20-25-30 CPY 14



15-20-25-30 CPY 22



CPY 17



15-20-25-30 CPY 23



CPY 18



15-20-25-30 CPY 24

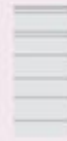

CPY 19

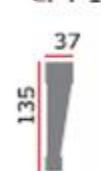

CPY 20



CPY 26



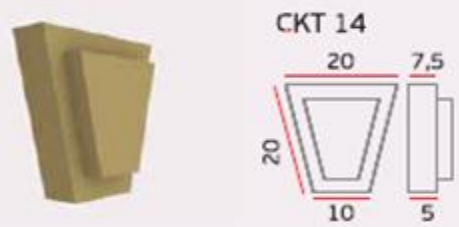
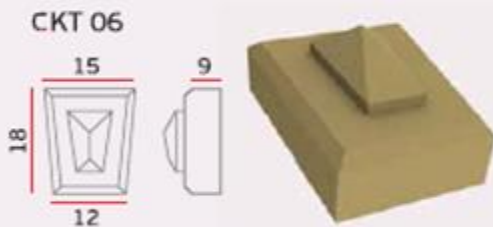
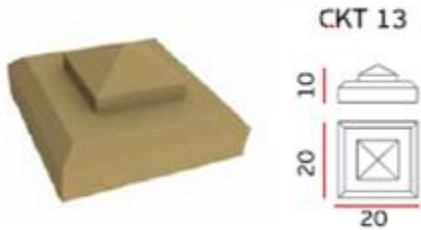
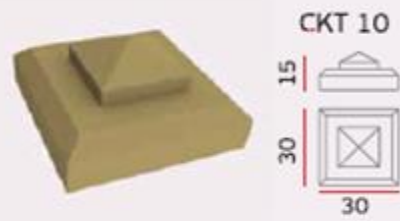
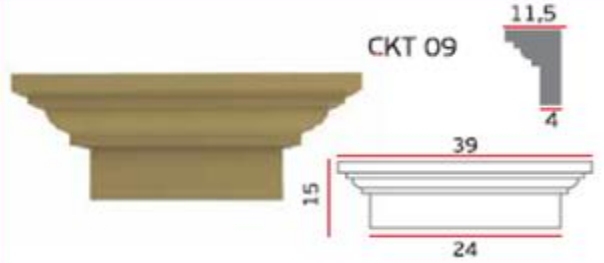
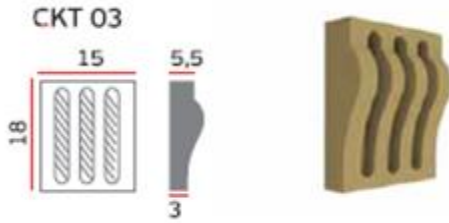
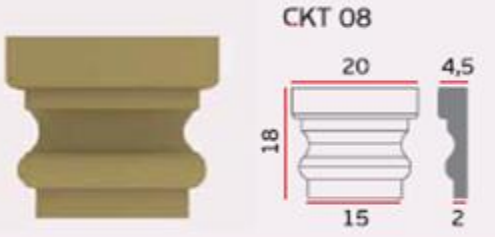
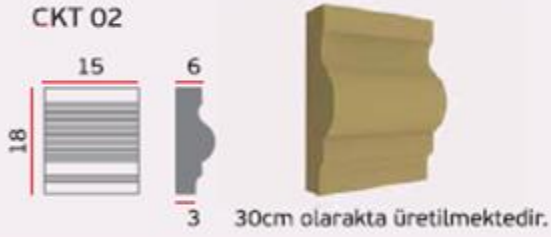
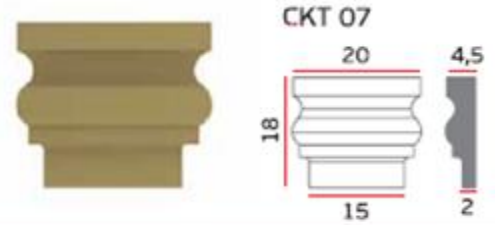
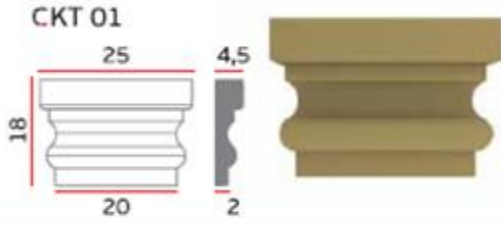

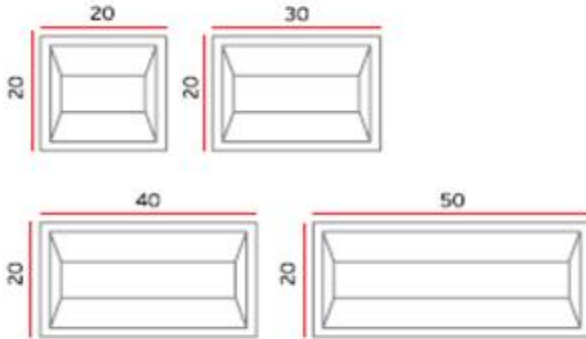
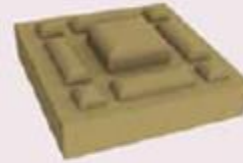
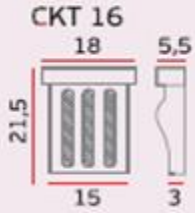
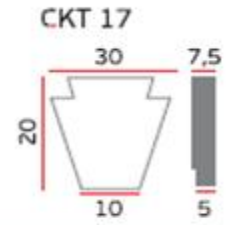
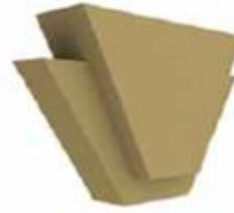
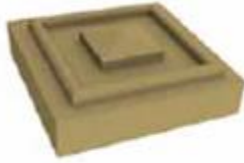
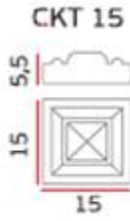

CKT 19



CRZ 01

50x50x7,5 cm



CRZ 05

50x50x6 cm

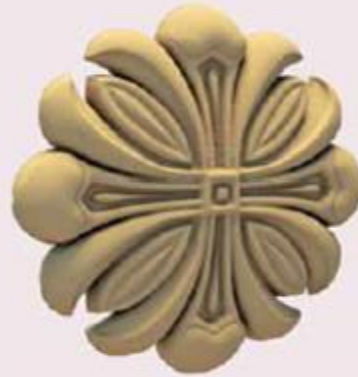

CRZ 02

50x50x5 cm



CRZ 06

50x50x7,5 cm



CRZ 03

50x50x5 cm



CRZ 07

75x75x5 cm



CRZ 04

50x50x6 cm



CRZ 08

50x50x6 cm



CAD 01
20x19x3



CBS 06
42x20x3

CAD 02
29x29x3



CYD 03
25x14x3

CAD 03
15x9x3



CYD 02
25x14x3

CBS 01
63x30x3



CPKD 01
32,5x32,5x3

CBS 02
50x31x3



CPKD 02
32,5x32,5x3

CBS 03
35x33x3



CMTF 01
50x50x3

CBS 04
50x50x3



CMTF 02
80x70x3

CBS 05
50x50x3



CMTF 03
100x50x3

CMTF 04
50x32x3



CMTF 10
50x100x5

CMTF 05
56x56x3



CMTF 11
50x100x5

CMTF 06
100x50x3



CMTF 13
50x50x3

CMTF 07
100x50x3



CMTF 14
42x150x5

CMTF 08
50x100x5



CMTF 15
43x100x5

CMTF 09
50x100x5



CMTF 16
41x100x5

CMTF 17
50x50x5



CMTF 24
50x50x5



CMTF 18
50x50x3



CMTF 25
50x50x5



CMTF 19
50x50x5



CMTF 26
50x50x5



CMTF 20
35x75x5



CMTF 27
80x98,5x5

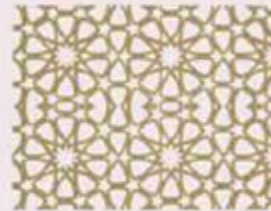

CMTF 21
50x50x5



CMTF 28
50x100x5



CMTF 23
50x50x5



CMTF 30
50x50x5



CFG 01



CFG 05

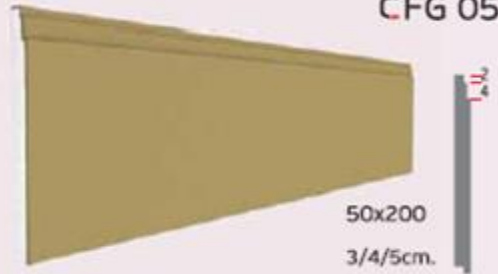

CFG 02



CFG 06

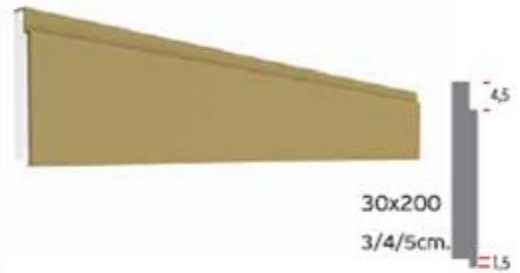

CFG 03

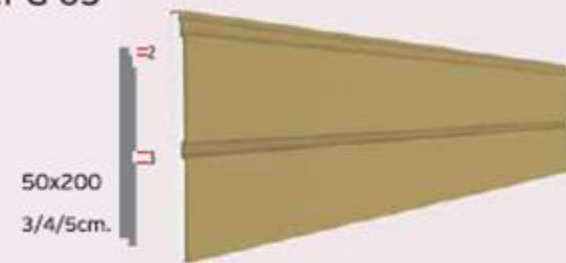

CFG 08

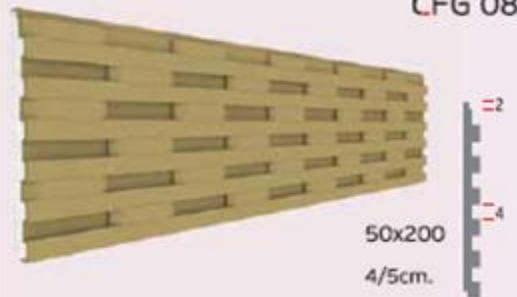

CFG 04



CFG 09

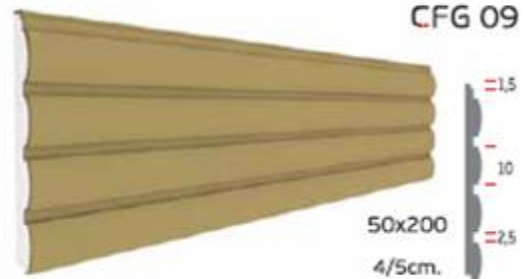

CFG 10

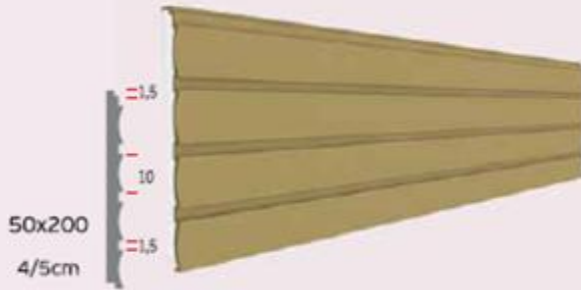

CFG 15



CFG 12



CFG 16



CFG 13

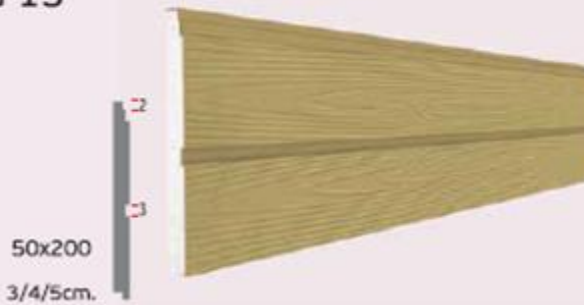

CFG 17

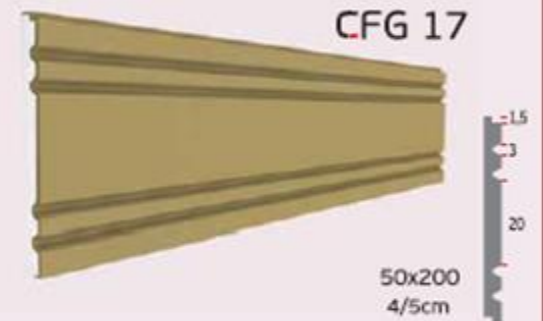

CFG 14



CFG 19

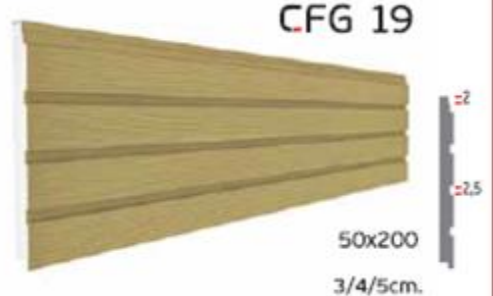

CFG 20

50x200
3/4/5cm.



CFG 52

50x200
4/5cm.

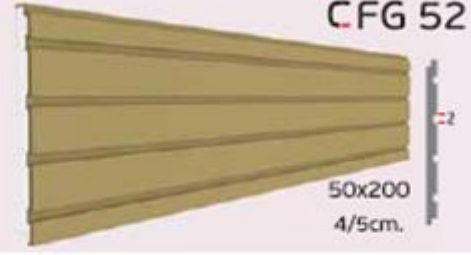

CFG 21 70x200

CFG 23 50x50

4/5cm *Kompozit görünümlü



CFG 62

50x200
4/5cm.

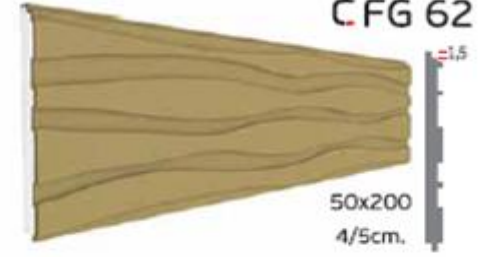

CFG 40

50x200
3/4/5cm.



CFG 63

50x200
4/5cm.



CFG 50

50x200
4/5cm.

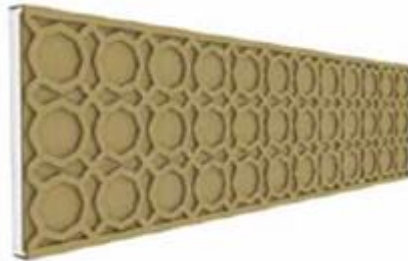

CFG 64

50x200
4/5cm.

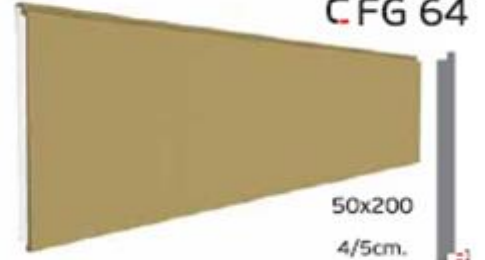

CFG 51

50x200
4/5cm.

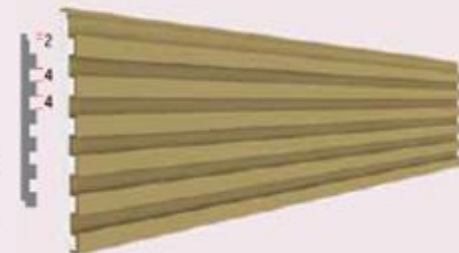

CFG 65

40x500
4/5cm.

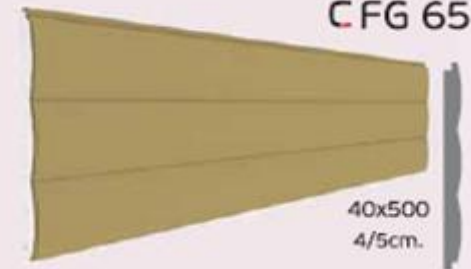

CTGK 01

20x200
4/5cm



CTGK 04

50x200
4/5cm

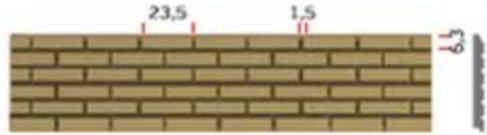

CTGK 02

40x200
4/5cm

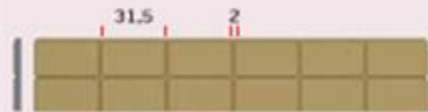

CTGK 07

50x200
4/5cm



CTGK 03

50x200
4/5cm



CTGK 09

50x200
4/5cm



CYB 01

50x200
4/5cm



CYB 02

50x200
3,5/4/5cm



CYB 03

50x200
3,5/4/5cm



CFG 35

120x50x5



CFG 46

130x50x5



CFG 36

120x50x4



CFG 47

120 x50x5



CFG 37

120x60x5



CFG 59

120x50x5



CFG 38

120x60x5



CFG 60

120x50x5



CFG 39

120x50x3,5



CFG 61

120x50x5



CFG 41

130x50x4,5



CFG 68

120x50x5





ÖRNEK FRANSIZ PENCERE 1



ÖRNEK FRANSIZ PENCERE 2



ÖRNEK FRANSIZ PENCERE 3



ÖRNEK FRANSIZ PENCERE 4



ÖRNEK FRANSIZ PENCERE 5



ÖRNEK FRANSIZ PENCERE 6



ÖRNEK PENCERE 1



ÖRNEK PENCERE 2



ÖRNEK PENCERE 3



ÖRNEK PENCERE 4



ÖRNEK PENCERE 5



ÖRNEK PENCERE 6



ÖRNEK PENCERE 7



ÖRNEK PENCERE 8



ÖRNEK PENCERE 9



Sertifkalarımız





Do you have any questions?

info@wsqgroup.com

 +965 655 231 09

www.wsqgroup.com

